

**HAYWARD®**

---

# SUPER VISION®

INTERNATIONAL

---

## *Pool & Spa Fiber Optic Lighting*

---



SYSTEM COMPONENT OVERVIEW .....	3
LAYOUT AND DESIGN .....	4
LENS SYSTEMS .....	5
INSTALLATION EXAMPLES .....	6
LIGHT SOURCES .....	7-8
CABLE .....	9
CONTROL SYSTEMS .....	10
FIBER HEAD INSTALLATION .....	11
TRACK INSTALLATION .....	12-18
LENS INSTALLATION .....	19-22
LANDSCAPE & ACCENT FIXTURES .....	23
TOOLS AND ACCESSORIES .....	24-25
TROUBLESHOOTING .....	26
WARRANTY .....	27



## INTRODUCTION

This manual was designed to assist the builder in the installation. Please read and understand this manual before beginning installation. If you have any questions, please call your Hayward representative.

### GENERAL TERMS

SuperVision uses *stranded optical fibers* in its products, that is many small fibers in a single cable as opposed to one large diameter fiber optic cable (also known as LCOF or large core optical fiber).

In general, there are two lighting methods with fiber optics:

**END LIGHTING** - light is directed from the light source through the fiber where it is emitted at the end. SuperVision has several *endglow™* lighting products for pool, spa, landscape, lens light and accent light. SuperVision *endglow™* fiber is protected by an outer PVC jacket with algaecide, fungicide and UV protectant.

**PERIMETER LIGHTING** - Fiber optics also emit light from the side as well as the end. SuperVision designed its patented perimeter lighting cable for maximum *sideglow™* properties. "Perimeter" refers to highlighting the *perimeter* of a pool or spa. Because there is no heat or electricity in the fiber optics, it is safe. The color-changing ability of fiber optics can make additional enhancements to most any project. SuperVision's perimeter *side-glow™* cables are engineered to withstand the rigors of the pool and spa environment.

No part of this document may be copied or reproduced in any form or in any means without written consent of Hayward. The information in this document is subject to change without notice. Products sold by Hayward are covered by warranty and patent indemnification provisions appearing in Hayward's Terms and Conditions of Sale. Hayward makes no warranty, express, statutory, implied, or by description, regarding the information set forth herein or regarding the freedom of description devices from patent infringement. Hayward makes no warranty of merchantability or fitness for any purpose. Hayward assumes no responsibility for any errors that may appear in this document.

# SYSTEM COMPONENTS & OVERVIEW

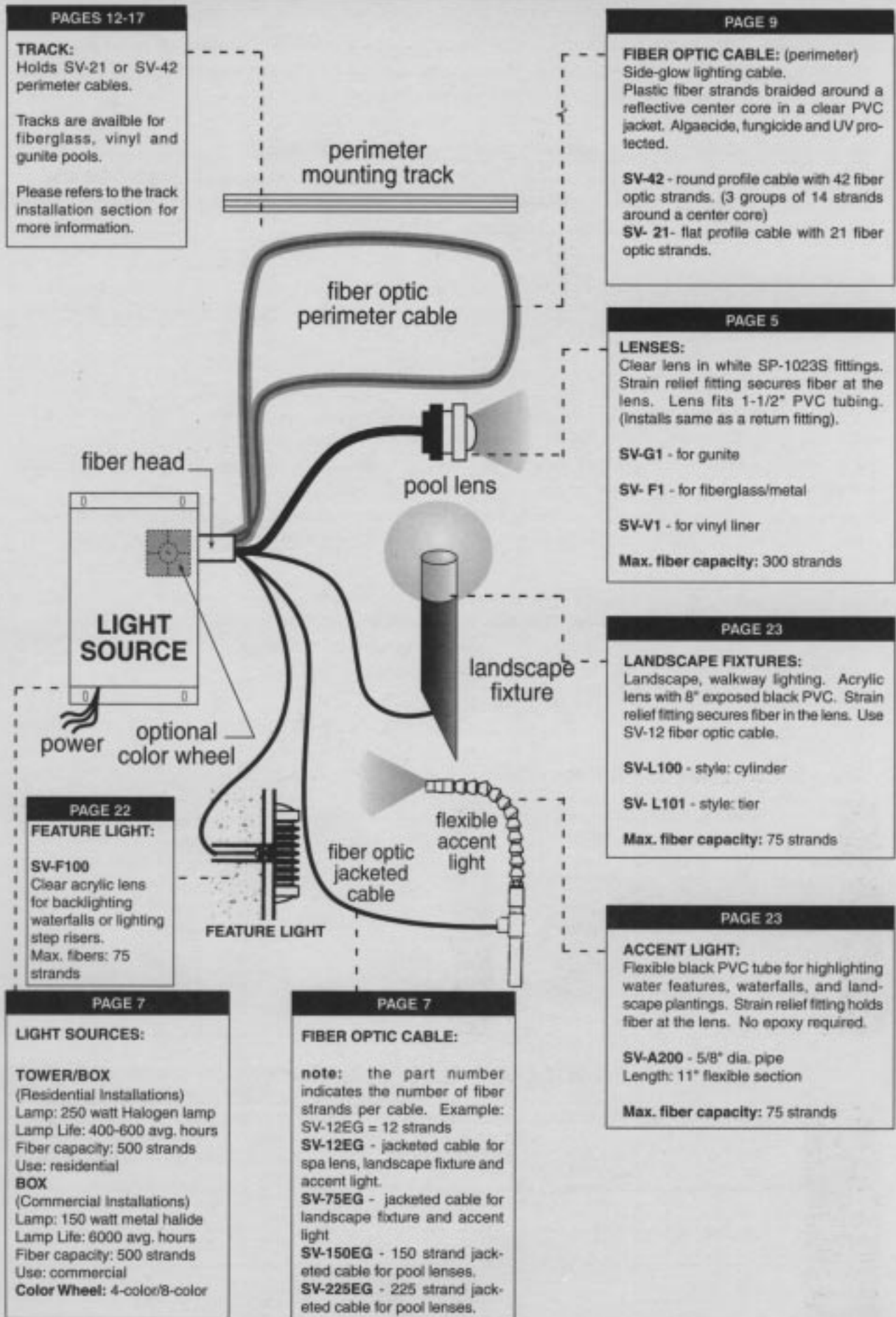

**PAGES 12-17**

**TRACK:**  
Holds SV-21 or SV-42 perimeter cables.

Tracks are available for fiberglass, vinyl and gunite pools.

Please refer to the track installation section for more information.

**PAGE 9**

**FIBER OPTIC CABLE:** (perimeter)  
Side-glow lighting cable. Plastic fiber strands braided around a reflective center core in a clear PVC jacket. Algaecide, fungicide and UV protected.

**SV-42** - round profile cable with 42 fiber optic strands. (3 groups of 14 strands around a center core)  
**SV-21** - flat profile cable with 21 fiber optic strands.

**PAGE 5**

**LENSES:**  
Clear lens in white SP-1023S fittings. Strain relief fitting secures fiber at the lens. Lens fits 1-1/2" PVC tubing. (Installs same as a return fitting).

**SV-G1** - for gunite  
**SV-F1** - for fiberglass/metal  
**SV-V1** - for vinyl liner

**Max. fiber capacity:** 300 strands

**PAGE 23**

**LANDSCAPE FIXTURES:**  
Landscape, walkway lighting. Acrylic lens with 8" exposed black PVC. Strain relief fitting secures fiber in the lens. Use SV-12 fiber optic cable.

**SV-L100** - style: cylinder  
**SV-L101** - style: tier

**Max. fiber capacity:** 75 strands

**PAGE 23**

**ACCENT LIGHT:**  
Flexible black PVC tube for highlighting water features, waterfalls, and landscape plantings. Strain relief fitting holds fiber at the lens. No epoxy required.

**SV-A200** - 5/8" dia. pipe  
Length: 11" flexible section

**Max. fiber capacity:** 75 strands

**PAGE 22**

**FEATURE LIGHT:**

**SV-F100**  
Clear acrylic lens for backlighting waterfalls or lighting step risers.  
Max. fibers: 75 strands

**PAGE 7**

**LIGHT SOURCES:**

**TOWER/BOX**  
(Residential Installations)  
Lamp: 250 watt Halogen lamp  
Lamp Life: 400-600 avg. hours  
Fiber capacity: 500 strands  
Use: residential

**BOX**  
(Commercial Installations)  
Lamp: 150 watt metal halide  
Lamp Life: 6000 avg. hours  
Fiber capacity: 500 strands  
Use: commercial

**Color Wheel:** 4-color/8-color

**PAGE 7**

**FIBER OPTIC CABLE:**

**note:** the part number indicates the number of fiber strands per cable. Example: SV-12EG = 12 strands

**SV-12EG** - jacketed cable for spa lens, landscape fixture and accent light.  
**SV-75EG** - jacketed cable for landscape fixture and accent light  
**SV-150EG** - 150 strand jacketed cable for pool lenses.  
**SV-225EG** - 225 strand jacketed cable for pool lenses.

## LAYOUT AND DESIGN

**▲ WARNING:** Proper precaution should be taken to insure sufficient lighting be provided when using this product for pathway lighting. Insufficient lighting can cause serious injury. Additional light sources may be necessary to provide sufficient lighting.

Lens placement should direct the light away from primary viewing positions.

With the focus on safety in the '90s the SuperVision fiber optic light system provides an extensive array of lighting solutions. Before you start to install this new lighting system, think about the layout and the way this system is going to be used by the homeowner.

### PLANNING/LAYOUT

Mount the light source(s) as close as possible to the entry/exit points of the fiber at the pool. Check local building codes (10 feet from the water or 5 feet, if a barrier exists).

### LENS LIGHTING

In the pool, mount the lens(es) 6-9" below the waterline.

In the spa, mount the lens in the footwell.

For single lens applications, refer to the pool finish chart below for the number of individual fiber optic strands needed. Mount the single lens in the deep end when possible.

Multiple lenses: Direct the lens toward areas on the opposite walls that will provide the largest reflective surface. Pool finish is a critical factor in light reflectivity. Lighter colors reflect fiber optic color best.

### 250H LIGHT SOURCE FIBER OPTIC CAPACITY EXAMPLE:

1 PERIMETER CABLE, SV-42 =	84 FIBER STRANDS
3 LENSES, 150/150/75 (SV-75) =	375 FIBER STRANDS
3 LANDSCAPE FIXTURES (12 fibers each) =	<u>36 FIBER STRANDS</u>
	<b>495 TOTAL FIBER STRANDS</b>

### POSSIBLE CABLE SPECIFICATONS

	SINGLE LENS (Deep end)				SINGLE LENS (Deep end)		
	Pool Finish	Length	#Fibers		Pool Finish	Length	#Fibers
Vinyl, Fiberglass, Gunite	white	up to 32'	150	Pebble Tec, Diamond Brite	light	up to 36'	225
	white	32' - 40'	225		light	up to 38'	300
	white	40' - 42'	300		dark	up to 34'	225
	medium	up to 36'	225		dark	up to 36'	300
	medium	up to 38'	300		black	up to 32'	225 (white light only)
	dark	up to 34'	225		black	up to 36'	300 (white light only)
	dark	up to 36'	300				
	black	not recommended					

### ENDGLOW™ CABLE MATRIX

	LANDSCAPE FIXTURES SV-L100 SV-L101	ACCENT LIGHTS SV-A100 SV-A200	FEATURE LIGHT SV-F100	STEP LENS SV/G1/V1/F1	SPA LENS SV/G1/V1/F1	POOL LENS SV/G1/V1/F1
SV-12EG	X	X	X	X	X	
SV-75EG		X	X		X	X
SV-150EG						X
SV-225EG						X

## SINGLE LENS SYSTEM

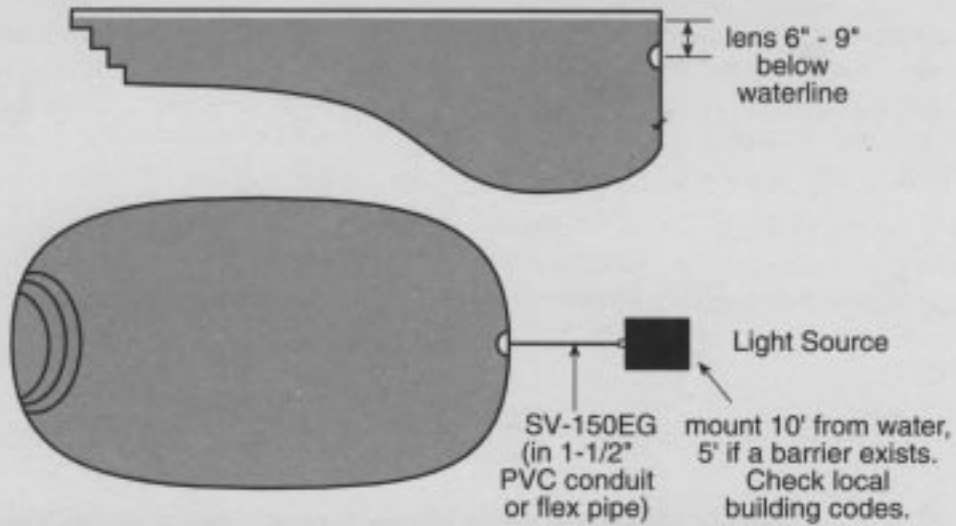

## MULTIPLE LENS SYSTEM

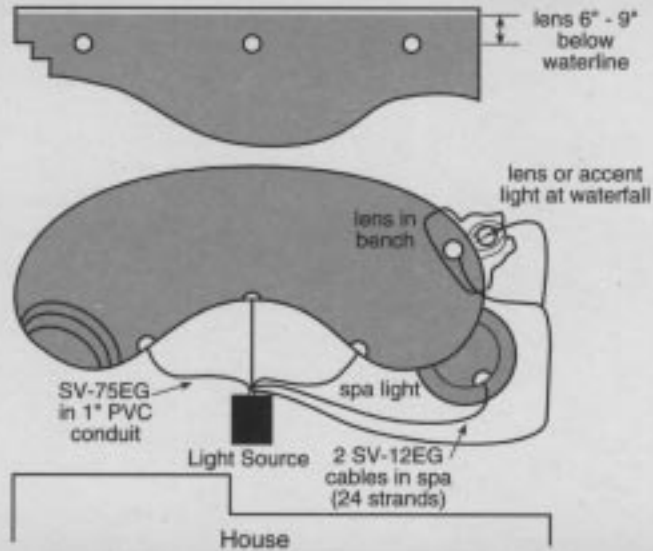

## MULTIPLE LENS SYSTEM & PERIMETER CABLE

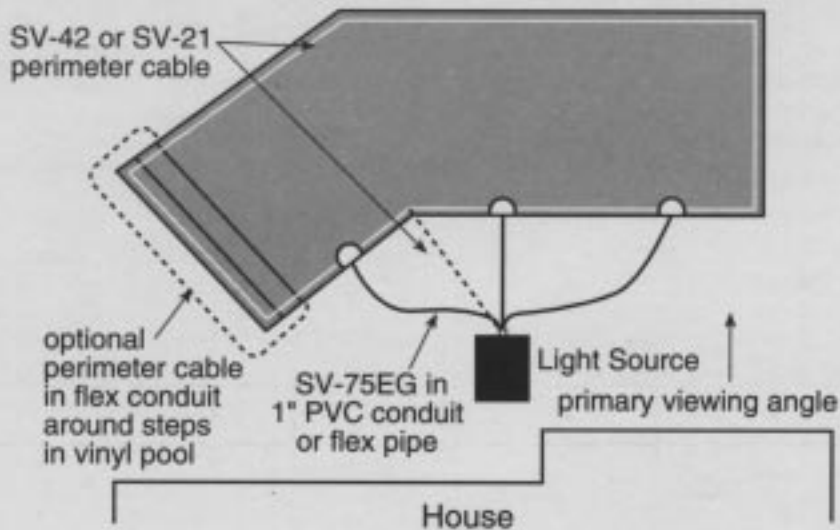

## INSTALLATION EXAMPLES

Position the light source no closer than 10 feet (3 meters) from the water surface. Next, mount the light source securely. Make sure that the area is well ventilated and free from residual water buildup and debris. At this point, you must ensure that a permanent electrical power is available to run the Super Vision light source. **Light source must be hard-wired. Check local codes.**

In the example (A) of the perimeter, the installation in a vinyl swimming pool show the cable NOT installed inside the stairs themselves. It is easier to enter and leave the pool's special receptor coping by starting at the side of the staircase at the coping, going all the way around, and exiting on the opposite side. Take both ends back to the light source shown in the shallow end.

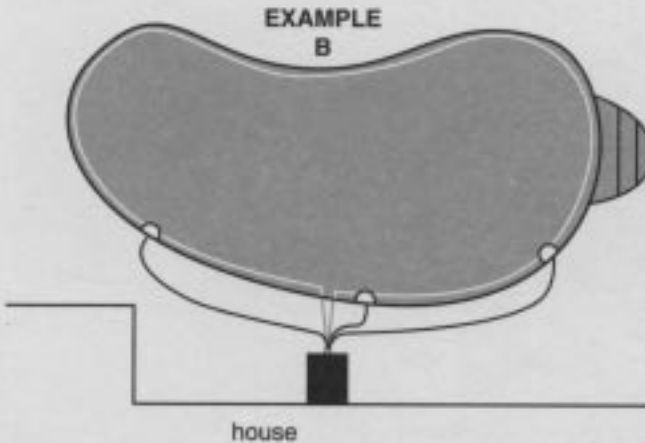
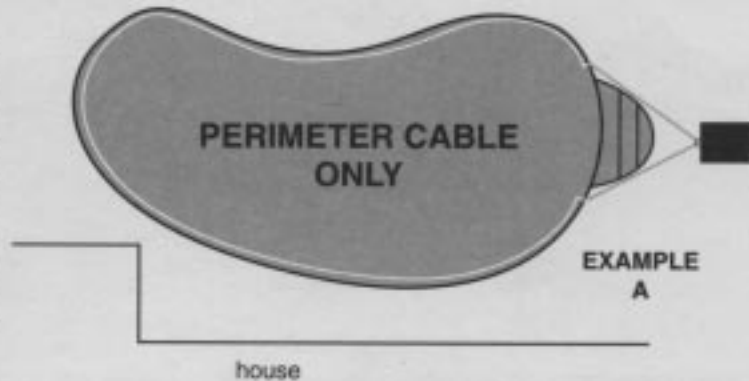

When adding underwater pool lighting along the side of the pool, it is important to note that, if possible, move the light source to the side nearest the house. This will shorten the length of the cable (SV-75) use for this application. In the second example (B), we will move the light source and add three lights on the side closest to the house. This allows light to spread away from the house rather than shine into it.

NOTE: The fiber for the perimeter (A) is taken outside and under the staircase. No adhesive is yet capable of adhering to vacuum formed staircases when subjected to excessive heat or freezing. It is not recommended to install inside the stairs.

It is possible to terminate the perimeter into an acrylic/fiberglass light fixture in the staircase, but it is very important that both runs of the perimeter cable be approximately the same length. In example (B), it would NOT be possible to terminate the perimeter cable in the staircase, as the two lengths would not be of equal length.

For the purposes of installing one light in the deep end, complete with the perimeter fiber, it is possible to terminate up to 300 fibers in the lens fitting. This will light up to 40 feet down the pool (refer to chart on page 3). It is also the perfect type of installation to terminate the perimeter cable into the light fixture installed in the staircase. As in example (C), we have one light in the deep end close to the light source, with termination of the perimeter in the shallow end staircase. Whether the pool is concrete, vinyl or fiberglass, it is important to note that the lighter the pool color the better the light will reflect off of the surfaces, and the better the color changes will be seen. Fiber optics are not recommended for black finished pools.

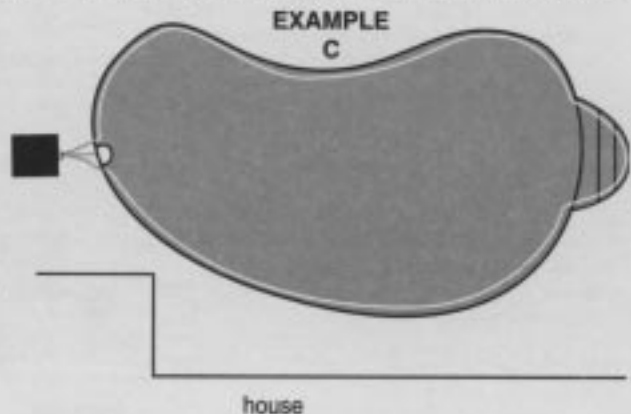

## LIGHT SOURCES

### SV-250H SERIES

**LAMP:** 250 watt halogen

**LAMP LIFE:** 400-600 average hours

**FIBER CAPACITY:** 500 strands

**DIMENSIONS:** 7.5"W x 12.5"L x 7.8"H  
(14.7"H with door open)

**MOUNTING:** Hard, flat surface or wall mount

The light source requires a hard flat surface (recommended minimum 18" x 18" concrete slab), it can also be wall mounted. The maximum number of fiber optic strands per light source is 500.

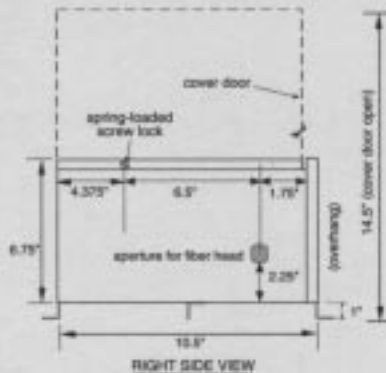

### MOUNTING FOR SV-250H:

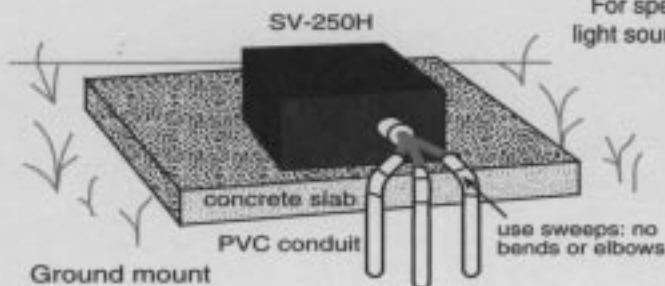

### WALL MOUNT:

For specifications, see the light source owner's manual

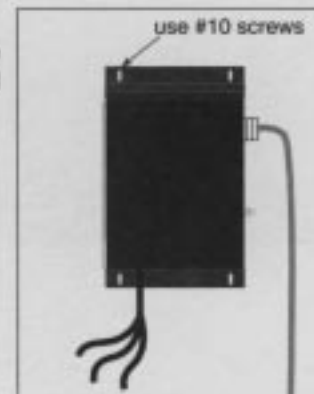

### SV-25T SERIES

**LAMP:** 250 watt halogen

**LAMP LIFE:** 400-600 average hours

**FIBER CAPACITY:** 500 Strands

**DIMENSIONS:** 20" H x 6.5" W x 7" L (tower)

8.5" x 9.75" x 1" (base)

**MOUNTING:** Cinder block or compacted ground

### DETERMINE INSTALLATION MOUNTING

1. Remove retaining screw between cover and shell assembly. Open lid, disconnect in-line connector to safety switch. Open lid and remove 2 screws connecting the flange to the chassis. (See Fig. #1)
2. Remove 2 screws connecting the chassis to the base. (See Fig.#2) Gently slide shell off the chassis.
3. Feed fiber cables through the bottom of the chassis. (See Fig.#3) Connect fiber cables to fiber head. (See "Fiber Head Installation" on page #11) Push fiber head into hole in lamp bracket on chassis. Turn to lock fiber head. Be careful not to deform bracket when performing this operation
4. Gently slide shell back over chassis. Connect shell to chassis by replacing 2 screws. Connect flange to chassis by replacing 2 screws.
5. With lid open connect in-line connector to the safety disconnect switch.



FIG #1



FIG #2



FIG #3

### CINDER BLOCK (8" x 8" block):

- Using the dimples on the chassis as a template, begin holes through to the cinder block.
- Remove base and continue to drill holes into the block.
- Reposition the base and attach to block with concrete anchors.(3/16" X 1 1/4" phillips flat head)
- Break off 4 caps attached to stakes and snap caps to base. (See diagrams)

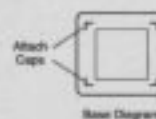

Base Diagram

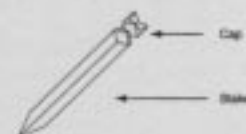

### GROUND MOUNTING (compacted):

- Position base.
- Break off 4 caps attached to stakes.
- Insert stakes in each corner of base.
- Drive stakes into corners with hammer to stabilize tower. (See diagram)

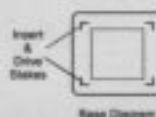

Base Diagram

## LIGHT SOURCES

### SV-2000 SERIES

**LAMP:** 150 watt metal halide

**LAMP LIFE:** 6000 hrs. average

**FIBER CAPACITY:** 500 strands

**DIMENSIONS:** 10"W x 12"L x 6.5"H  
(15.75"H with door open)

**MOUNTING:** Wall mount

The SV-2000 is a hard-wired commercial light source. It must be wall mounted. Maximum fiber capacity is 500 strands.

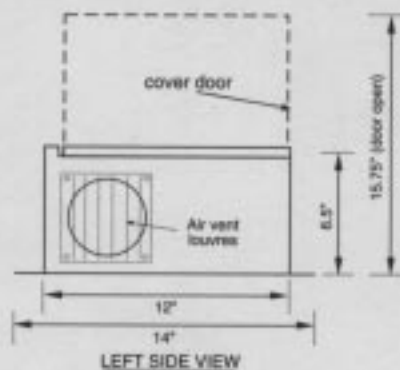

## LIGHT TOWER OPERATING INSTRUCTIONS

### SV-25TH 4/8X Series

1. Refer to "Controller X-10 Powerhouse Instructions" on page #10.

### SV-25T Series

1. Your system is equipped with an on-off switch located on the back of your unit. (See Fig. #1)
2. **Optional**  
Your system is equipped with a colorwheel on-off switch located to the left of the on-off switch on the back of your unit. (See Fig. #1)

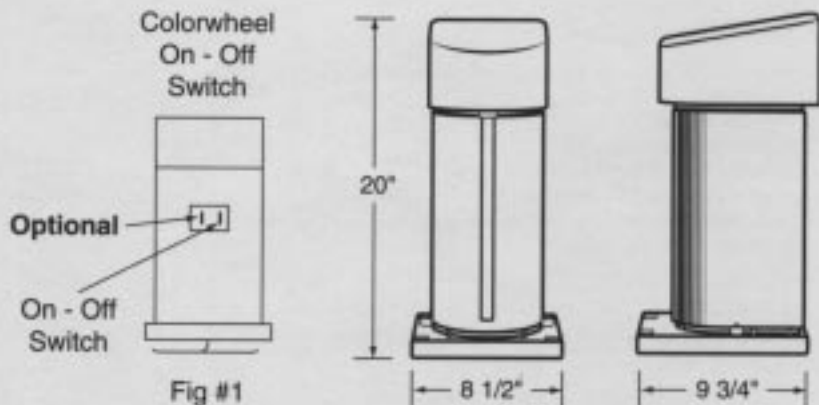

### SV-25TH 4/8J Series

1. Refer to wiring diagram instructions provided with remote system.

### GENERAL INFORMATION FOR LIGHT SOURCES:

1. Have proper voltage at site. Voltage requirements for light sources may be specified at time of order. (Refer to figure on this page for power requirements or refer to the label on the back of the illuminator.)
2. Mount the light source in an area that has good ventilation and clearance for fan intake and exhaust. Avoid placing multiple illuminators in positions that place air exhaust and air intake vents near each other.
3. Avoid dusty areas.
4. Be sure the mounting location will allow access for bulb replacement and that there is enough clearance for the light source lid to be opened.
5. The mounting location must be a minimum distance from water, based on local, county or state building codes. Use GFI circuit breakers when installing near water.
6. For mounting use #10 screws or bolts.
7. Do not operate without lamp in place. Allow lamp to cool before removing. Replace with lamps supplied by Hayward or authorized distributor.

**NOTE: SPECIFICATIONS, BULB & FUSE REPLACEMENT - Refer to owner's manual.**

## CABLE

### SV-42

**Diameter:** 3/8" (9.53mm)

**Type:** side glow, multistrand braided plastic fiber optics.

**Bend Radius:** 1/2" minimum

**Max. Recommended Length:** 200'

**Note:** Will fit 5/16" track extrusions. Excellent when difficult or tight bends are required.



SV-42  
cross-section



actual size

Manufactured under one or more of these patents:

#5333228, 5376201

### SV-21

**Diameter:** 5/16"H x 5/8"W

**Type:** side glow, multistrand plastic fiber optics.

**Bend radius:** 1"

**Max. Recommended Length:** 200'

**Note:**

Perimeter cable designed to fit existing industry flat and oval tracks. Or may be secured with double-sided tape and silicon



SV-21  
cross-section

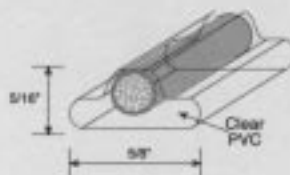

actual size

Manufactured under one or more of these patents:

#5333228, 5376201

#### NOTE FOR SV-42 AND SV-21:

Run cable in 1-1/2" PVC conduits. The conduits should be run at the same depth as the entry/exit points as the fiber. Use sweep PVC radiuses, avoid 90° bends or elbows. Make sure you have enough fiber before cutting. Allow 4-6" excess at the lens and allow approximately 16" excess at the light source. Be careful not to bend or scratch the fiber excessively. This could affect light transmission and output.

### SV-12EG

**Diameter:** 1/4"

**Type:** Black jacket with unbraided fiber optic strands.

**Recommended uses:**

Landscape fixture lighting, spa and lens lighting.



SV-12EG actual size

### SV-75EG

**Diameter:** 7/16" (11.11mm)

**Type:** Black jacket with 75 unbraided fiber optic strands.

**Recommended uses:**

End point fixture lighting.



SV-75EG actual size

### SV-150EG

**Diameter:** 5/8"

**Type:** Black jacket with 150 unbraided fiber optic strands.

**Recommended uses:**

Task lighting, downlighting, wall washing.



SV-150EG actual size

## CONTROLLER • X-10 POWERHOUSE

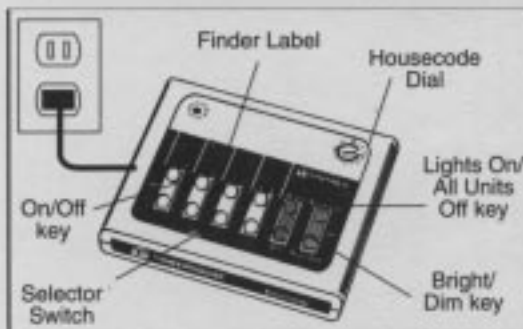

### X-10 POWERHOUSE, MINI CONTROLLER MC460

This controller lets you remotely control up to 8 X-10 Modules from any convenient location in the home. You can turn on all lights connected to Lamp Modules and Wall Switch Modules with the push of a button, and even control landscape and accent lighting through wall switches with the Wall Switch Modules.

The Mini Controller transmits signals to the Modules over existing house wiring. The Modules respond to command signals which turn lamps on and off, dims and brightens any incandescent lamp up to 300 watts. The Wall Switch performs the same tasks up to 500 watts.

#### TO INSTALL THE MINI CONTROLLER:

1. Plug the power cord into any functioning 120V outlet.

2. Using a small screwdriver, choose one of the 16 letters on the Mini Controller's Housecode dial. All X-10 Modules have a similar red Housecode dial. Set the Mini Controller and all the Modules to be controlled by it to the same Housecode letter. Having 16 choices for the Housecode enables you to set up several independent systems in one home without interaction among them.

#### INSTALL AND SET UP THE MODULES (SOLD SEPARATELY)

1. Install and set up all of your X-10 Modules referring to the instructions included with them. Be sure to turn off the power at the circuit breaker panel when installing Wall Switch Modules.

2. Set all of your Modules to same Household as you set on the Mini Controller.

3. Set each Module to a Unit Code between 1 and 4 (or between 5 and 8 if you set the Selector Switch on the Mini Controller to 5-8).

**TO TURN ON A LIGHT SOURCE** - Press and release the top of one of the 4 number keys corresponding to the Unit Code set on the Module to be controlled.

**TO TURN OFF A LIGHT SOURCE** - Press and release the bottom of one of the 4 number keys corresponding to the Unit Code set on the Module to be controlled. The "Selector Switch" selects whether keys 1 through 4 control Modules set to 1 - 4 or 5 - 8.

**TO DIM OR BRIGHTEN LIGHTS** - Press and release the top of the number key for the Lamp Module or Wall Switch Module you wish to dim or brighten. Then press the top of the Dim/Brighten key to brightened or the bottom of the Dim/Brighten key to dim the light. Hold the key pressed until the desired brightness level is reached.

**TO TURN ALL THE LIGHTS ON** - Press the top of the All Lights On/All Units Off key to instantly turn on all lights connected to Lamp Module and Wall Switch Modules (which are set to the same Housecode as the Mini Controller).

**TO TURN ALL THE LIGHTS OFF** - Press the bottom of the All Lights On/All Units Off key to instantly turn on all lights connected to Lamp Module and Wall Switch Modules (which are set to the same Housecode as the Mini Controller).

The Finder Label is a convenient place to indicate the locations of lights controlled by the system. There is one box for each unit key.

#### PROBLEM SOLVING:

**If a particular Module won't go on or off from the buttons on the Mini Controller:**

1. Check that there is power to the outlet controlling the Module and the switch on the light is ON.
2. Check that the Unit Code on the Module is set to the correct number. Check that the Housecode on the Module is set correctly. The Housecode on the Module and the Mini Controller must be set to the same letter.
3. Try plugging and the Mini Controller into the same outlet as the Module. If the Module doesn't work on any outlet, replace the Module. If the Module works in some outlets but not in others, contact 1-800-526-0027 for help.

**If no Modules can be controlled from the Mini Controller:**

1. Check that there is power to the outlet for the Mini Controller.
2. Check that the Housecode on the Mini Controller is set correctly.
3. Try plugging the Module and the Mini Controller into the same outlet. If none of the Modules work in any outlet, replace the Mini Controller. If the Mini Controller works in some outlets but not in others, contact 1-800-526-0027 for help.

**POWER INTERRUPTIONS** - When the power is restored after an outage, Lamp Modules and Wall Switch Modules will normally be off.

#### MANUAL CONTROL:

Lights connected to plug-in Modules can be turned on with their own power switch. Turn the switch off then on again once or twice.

The Wall Switch Module can be turned on or off locally using its push button. The power On/Off switch on the Wall Switch Module is used to completely turn the power off.

#### SAFETY PRECAUTIONS (Do not exceed the ratings of the Modules):

**Lamp Module** - 300 watt max., incandescent only.

**Wall Switch Module** - 500 watts max., 60 watts mini., incandescent only.

**Appliance Module** - appliances rated 15 Amp. resistive or 1/3hp motor load, or 400 watts for TV sets, or 500 watts for lamps due to the "inrush current" from a cold lamp. (Do not use for "instant-on", heavy duty or any appliances which should not be left unattended.

**Wall Switch and Lamp Module** - Do not use with fluorescent, mercury, sodium or low voltage lights. Incandescent only. Do not use a Wall Switch Module for a lamp that already has a dimmer on it. Do not use a Wall Switch Module to control an outlet unless it is certain that no other appliance will be plugged into that outlet.

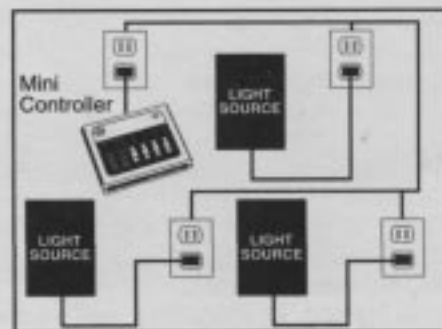
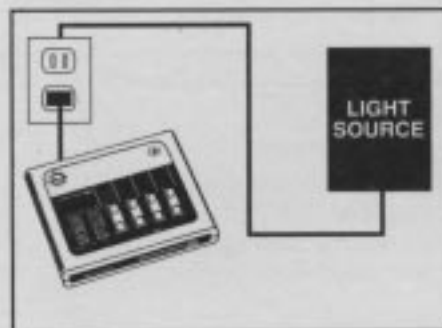

# FIBER HEAD INSTALLATION

## FIBER HEAD FOR SV-250H

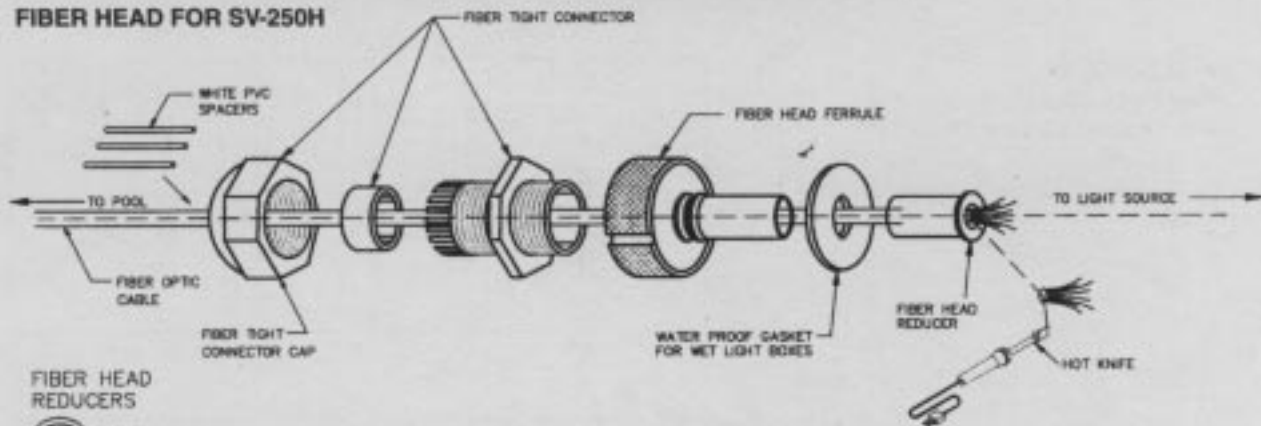

### FIBER HEAD REDUCERS

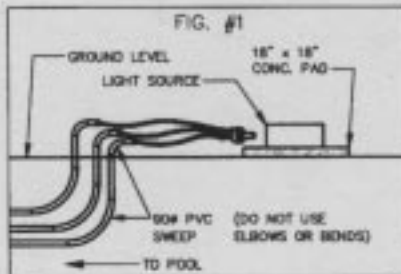
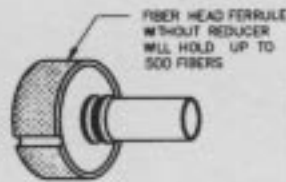
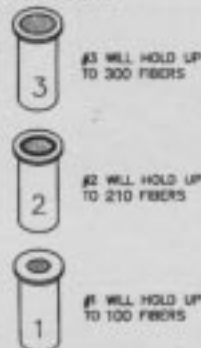

### INSTRUCTIONS

1. Make sure all fiber optic cable coming out of the ground conduit to be of enough length to reach the light source. See Fig #1 (We recommend an extra 1' of fiber cable for connection to light source and for future disassembly/reassembly).
2. Expose the fiber strands by removing approximately 8" of the black or clear PVC outer covering. (For the clear jacket, a reflective white PVC center core tube must be removed.) Caution: do not cut or scratch the exposed fibers.
3. Feed fiber through the connector cap, fiber head ferrule until 1/2" - 1" of raw fiber will come through the fiber head ferrule. NOTE: If fibers do not fill the fiber head ferrule, use one of the three reducers to fill up the space. Make sure the reducer is fully seated. Fill any space with waste fiber strands. Tighten the connector cap with a wrench or pliers to prevent the fibers from slipping in the head. Use white PVC spacers (provided) to help tighten the head.
4. Using a hot knife, cut the exposed fibers flush. Protruding fibers can interfere with the color wheel movement. To cut fibers, do not use an excessive "sawing" motion. Apply even pressure on the fibers. NOTE: Allow the hot knife to fully heat up before cutting. It is important to allow the heat to cut the fibers. (Caution: sawing back and forth will damage the fibers.)
5. For a wet location light source, it is necessary to use the water-resistant gasket. A waterproof gasket is provided with an adhesive backing. Adhesive side towards the fiber head.
6. The fiber head is now ready to be inserted into the light source. To insert: the notch must face up to match the opening in the light source. Make sure fiber head slides all the way through the motor plate. To lock: turn 90° clockwise. NOTE: Sometimes it will be a little hard to insert the fiber head on a new light source for the first time.

## FIBER HEAD FOR SV-25TH

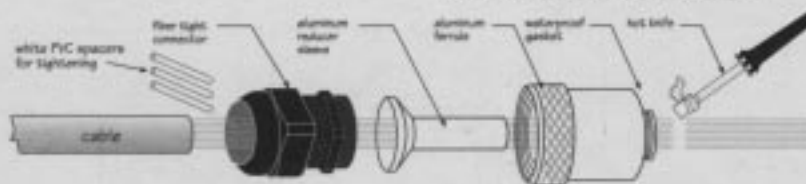

## FIBER HEAD FOR SV-2000

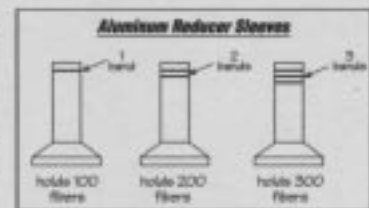
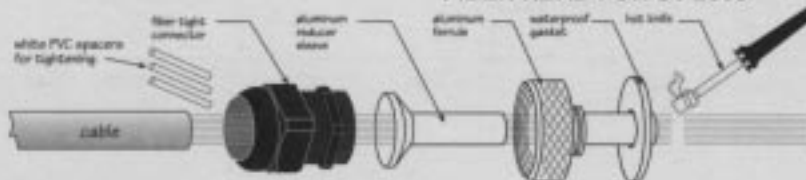

### INSTRUCTIONS

1. Expose the fiber strands by removing approximately 8" of the black or clear PVC outer covering. (For the clear jacket, a reflective white PVC center core tube must be removed) Caution: do not cut or scratch the exposed fibers.
2. Feed fibers through the fiber tight connector reducer if necessary, then through the aluminum ferrule until 1/2"-1" of raw fiber will come through the aluminum ferrule. NOTE: If the fibers do not fill the fiber head ferrule, use one of the three reducers to fill up the space. Tighten the connector cap with a wrench or pliers to prevent the fibers from slipping in the head. Use white PVC spacers (provided) to help tighten the head.
3. Using a hot knife, cut the exposed fibers as flush as possible. Protruding fibers can interfere the color wheel movement. To cut fibers, do not use a "sawing" motion. Apply even pressure on the fibers. NOTE: Allow the hot knife to fully heat up before cutting. It is important to allow the heat to cut the fibers. (Caution: sawing back and forth will damage the fibers)
4. For a wet location light source, it is necessary to use the waterproof gasket. A waterproof gasket is provided with an adhesive backing. Adhesive side toward the fiber head.
5. The fiber head is now ready to be inserted in the light source. To insert: the notch must be face up to match the opening in the light source. Make sure the fiber head slides all the way through the motor plate. To lock: turn 90° clockwise. NOTE: Sometimes it will be a little hard to insert the fiber head on a new lightsource for the first time.

# PERIMETER TRACK FOR GUNITE POOLS

## STEGMEIER FORMS

Fiber Optic Capstone - S for SV-42  
 Fiber Optic Capstone - F for SV-21

Includes Styrofoam forms for poured in place concrete decks.

SV-21

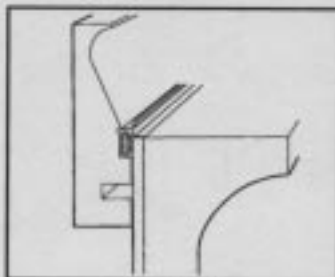

SV- SC21

SV-42

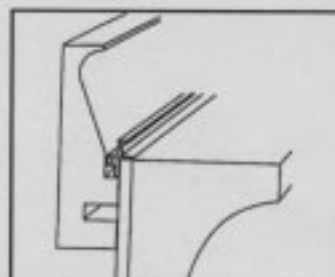

SV- SC42

## STEGMEIER TRACK ONLY

No Styrofoam forms. Use double-sided tape and Novaguard silicon with installation. Refer to page 24.



SV- ST21

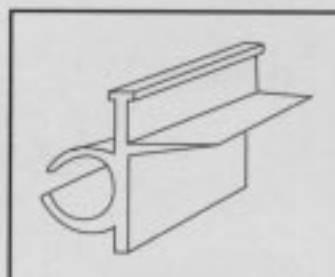

SV- ST42

## STEGMEIER BOND BEAM TRACK

For stone, brick and cast coping. Gunite pools only. With tile in place so that channel may be held with double-sided tape.

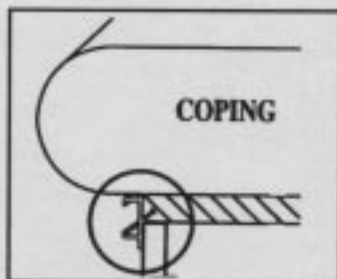

SV- BB21

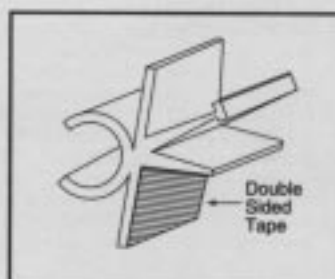

SV- BB42

## STEGMEIER FIBER OPTIC - LS, VK (After Market track)

Saw 1/8" slot 5/8" deep above the tile using a diamond blade. Track will lock into groove. For SV-42 only.

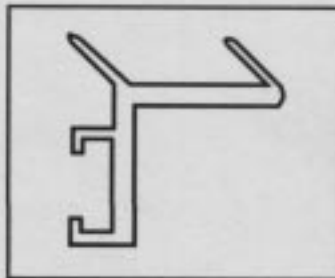

SV- LS21

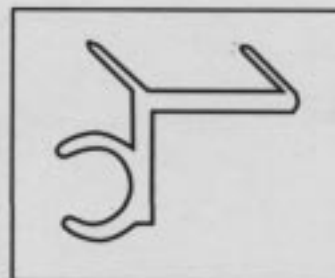

SV- LS42

## PERIMETER TRACK FOR VINYL LINER POOLS

### STEGMEIER PERIM-A-LIGHT CANTILEVER FORMS

Includes Styrofoam forms for poured in place concrete decks and track for Super Vision SV-21 or SV-42 perimeter cables.

SV-21



SV-CL21

SV-42

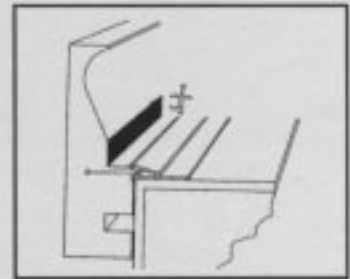

SV-CL42

### SUPERVISION SV-V21 & SV-V42 TRACKS

Snaps over liner bead.

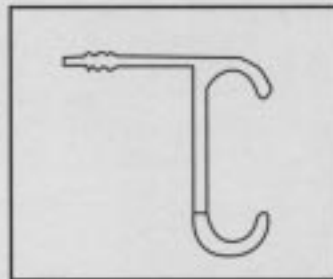

SV-V21

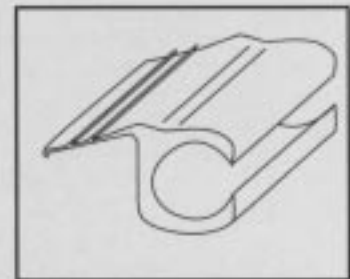

SV-V42

## PERIMETER TRACK FOR FIBERGLASS POOLS

### SUPERVISION CLEAR TRACK - SV-T42

For double-sided tape and Novagard silicon adhesive. See page 24.

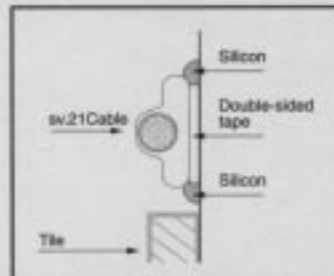

SV-21

Double-sided tape and silicon adhesive. Use SV-X4 tape.

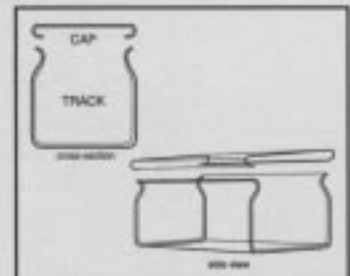

SV-42

Use SV-X2 tape

# TRACK INSTALLATION

## GUNITE

1. Stegmeier with styrofoam deck forms
2. Stegmeier track without deck forms for stone, brick, and cast coating

### SV-21

X  
X

### SV-42

X  
X

## VINYL

1. Stegmeier concrete deck form and track
2. Vinyl liner snap-in track

### SV-21

X  
X

### SV-42

X  
X

## FIBERGLASS

1. Clear track
2. Double-sided tape (0°F limit) and silicon

### SV-21

X

### SV-42

X

## I. GUNITE

1. Stegmeier deck forms. For concrete cantilever decks with a built-in white track that accepts Super Vision SV-42 and SV-21 *sideglow™* perimeter cable. Refer to Stegmeier Fiber-Optic Capstone-S (figure 2) for instructions. For SV-21, use Stegmeier Capstone-F (figure 1).

2. For bond beam installations use Stegmeier Bond Beam Track. The track will rest on top of the tile. Paper-covered transfer tape will hold the track in place on curves or bends while the Bond Beam is set.

For SV-21, use Stegmeier Capstone-F.

For SV-42, use Stegmeier Capstone-S.

3. Clear track with double-sided tape and silicon. Use only where the temperature does not drop below 0°F. Apply the tape to the top of the tile line. Remove the protective covering and press the track into place. The track can be notched to accept bends and radiuses. Apply a bead of silicon (Novagard) to the top and bottom of the track. (figure A, below)

4. Clear track with stainless steel anchors. Drill holes and insert plastic concrete anchors approximately 1' on center. Double-sided track can be applied for added security. Seal the top and bottom of the track with silicon. (figure B, below).

## II. VINYL

1. For SV-21 and SV-42 when using a poured deck. Refer to Stegmeier instructions. (figure 3)

2. For SV-42 and SV-21 use SV-V42 or SV-V21. It comes in 6' sections. The track is snapped into the liner bead in the coping. No silicon is needed. After the track is installed snap the cable into place. (figure C, below)

## III. FIBERGLASS

1. Use self-tapping stainless steel screws approximately 1' on center. Seal the top and bottom of the track with silicon for added security. OPTION #2: Apply double-sided tape to the pool surface. (Caution: DO NOT apply double-sided tape in regions where the temperature drops below 0°F). Add a bead of silicon to the top and bottom of the track.

2. For SV-21 use double-sided tape. Apply the tape first, then press on the cable. Apply a bead of silicon (Novagard) to the top and bottom of the cable. (figure D, below)

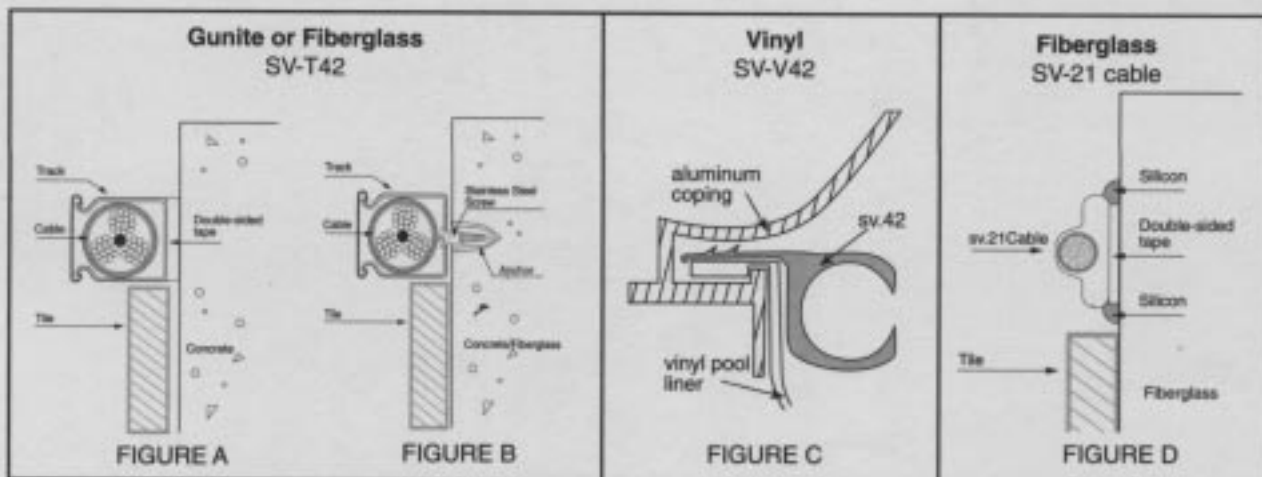

## PERIMETER TRACK • GUNITE - STEGMEIER CAPSTONE - F

**SUPERVISION**  
PART NO. SV-CF21

**FIGURE 1**

Use with Super Vision SV-21 fiber optic cable  
Quick set system takes less than one hour to set and be finished with the new fiber optic lighting.  
No tape or gun grade caulking to fasten the channel. Stegmeier Corp. furnishes the channel with the form.  
The concrete contractor inserts the channel in the cantilever form, in place of the tile strip.  
After the concrete has set, start the first 2" of tubing with your finger and then use Hayward's SV-RLR roller on the lower edge.

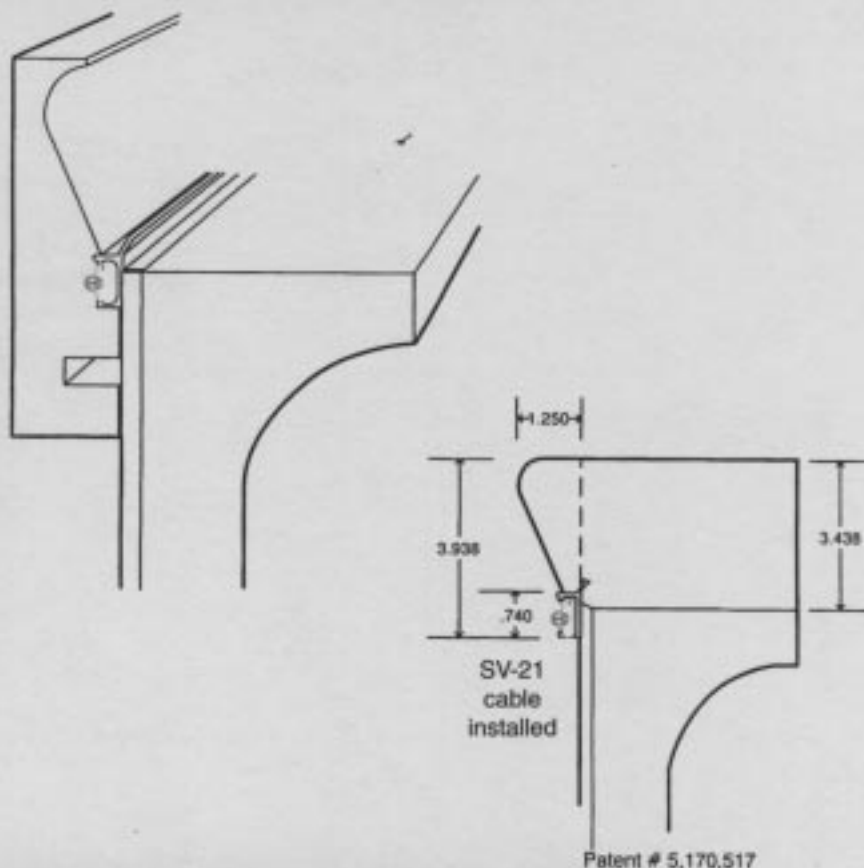

## PERIMETER TRACK • GUNITE - STEGMEIER CAPSTONE - S

**SUPERVISION**  
PART NO. SV-CS42

**FIGURE 2**

Use with Super Vision SV-42 fiber optic cable  
Quick set system takes less than one hour to set and be finished with the new fiber optic lighting.  
No tape or gun grade caulking to fasten the channel. Stegmeier Corp. furnishes the channel with the form.  
The concrete contractor inserts the channel in the cantilever form, in place of the tile strip.  
After the concrete has set, start the first 2" of tubing with your finger and then use Haywards SV-RLR roller on the lower edge.

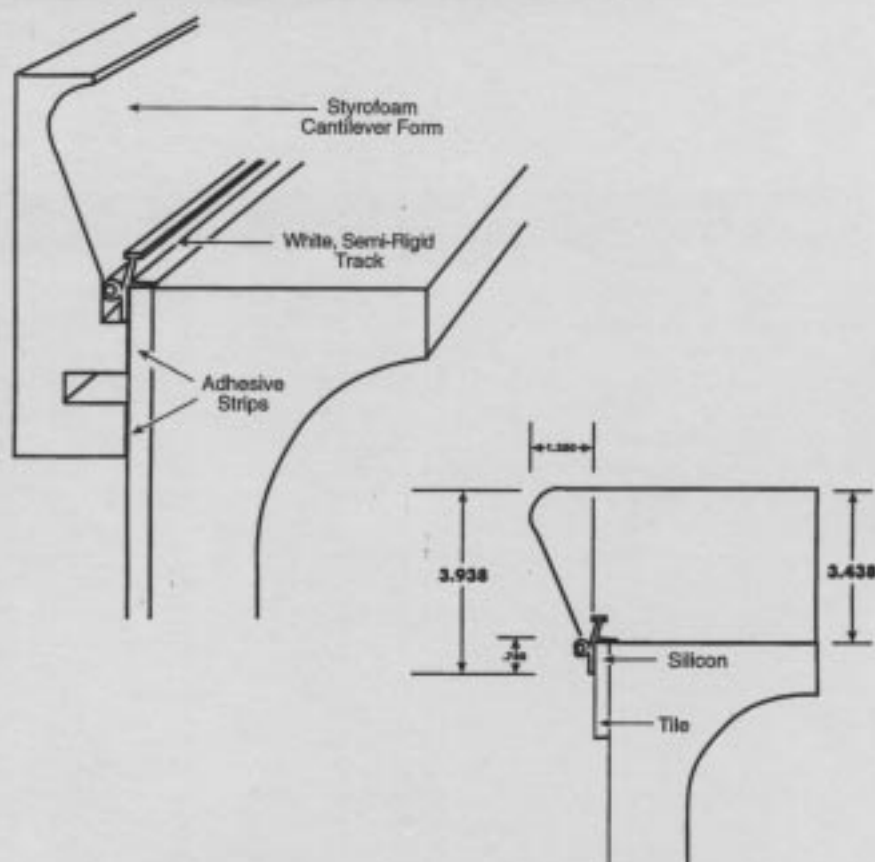

## PERIMETER TRACK • VINYL - STEGMEIER CAPSTONE

This form is used without wires, keys, tape or tubes of glue.

### How to use the Frontier "Clip-Loc" form:

After the liner track is securely in position, begin pressing the outermost rib into the clip of the liner track. There is no need for concern about the elevation alignment because the rib is being guided into the track. There is a "clip-loc" every six inches to keep the form securely fastened to the track. As you come to each "clip", listen for the "snap" as you press them with the palm of your hand.

The adhesive feet attach themselves at the correct elevation. More importantly, the cement you pour against these forms cannot get down into the liner track, eliminating track cleanup.

### How to remove the Frontier "Clip-Loc" form:

When the concrete has become firm enough to remove the forms, simply grasp the "pull tapes".

## TRACK

1. Using self-tapping screws, fasten the liner receiver to the panels, being sure that the lower lip of the track is set flush with the face of the panel.
2. After the liner track is securely in position, begin pressing the outermost rib into the lip of the liner track. There is no need for concern about the elevation alignment because the rib is being guided into the track. There is a "clip-lock" every six inches to keep the form securely fastened to the track. As you come to each "clip" listen for the snap as you press them with the palm of your hand.
3. Now using 2" fiber-optic inserts between each section of fiber optic receiver (to guarantee alignment), remove the paper from each section as you proceed. If removed ahead of bonding area, the tape could collect dust and not allow proper adherence. Make sure that the base of the receiver sits down tight in to the foam shelf.
4. Cut off ends of nose caps (not supplied in box) to fit flush with top of fiber optic receiver.
5. When pouring concrete, be sure to vibrate the forms sufficiently to prevent "honey-combing".
6. Wait as long as possible before stripping the forms so as not to loosen concrete grip on the fiber optic receiver.

# PERIMETER TRACK • GUNITE BOND BEAM

SUPERVISION PART NO. SV-BB21

Stone, brick and cast coating. For gunite pools only.  
With tile in place so that channel may be held with double-sided tape.

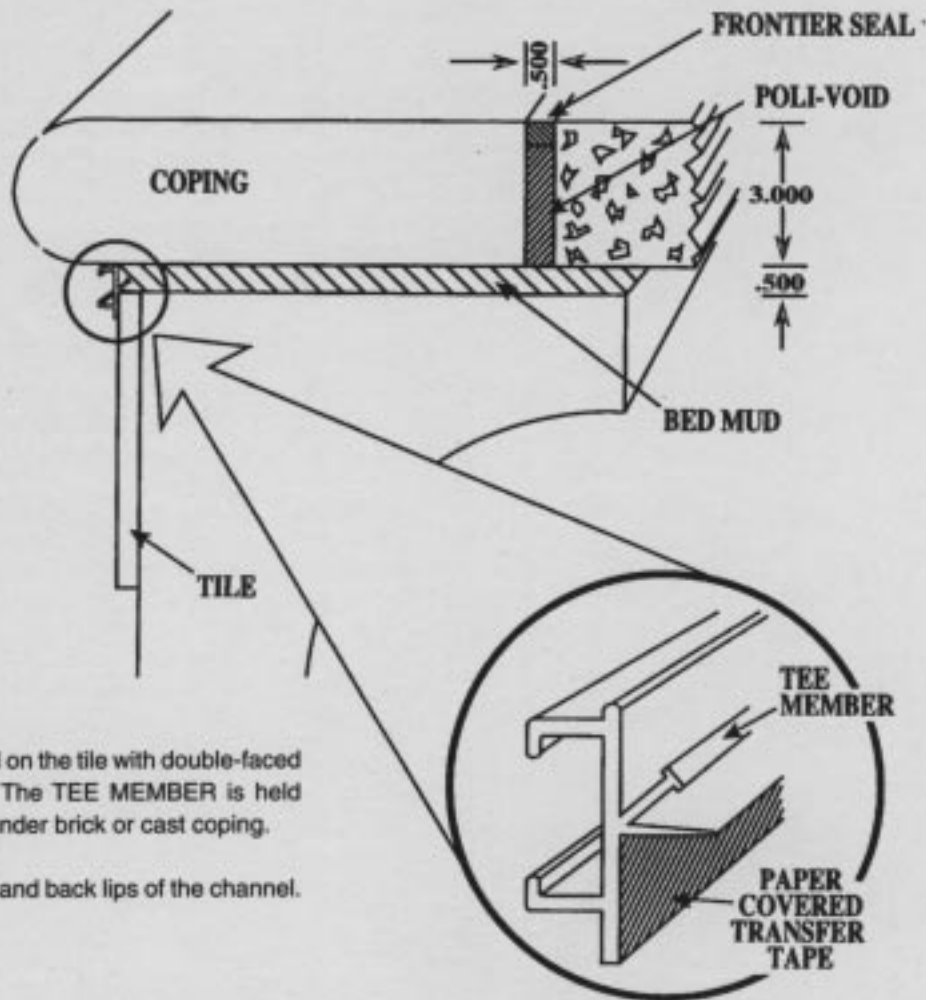

**Fiber Optic II** is positioned on the tile with double-faced pressure sensitive tape. The TEE MEMBER is held permanently in bed mud under brick or cast coping.

On tight radii, cut the front and back lips of the channel.

Available in 8' lengths.

SUPERVISION PART NO. SV-LS21, SV-LS42

**CAUTION: POOL MUST BE EMPTY TO PREVENT ELECTRICAL SHOCK**

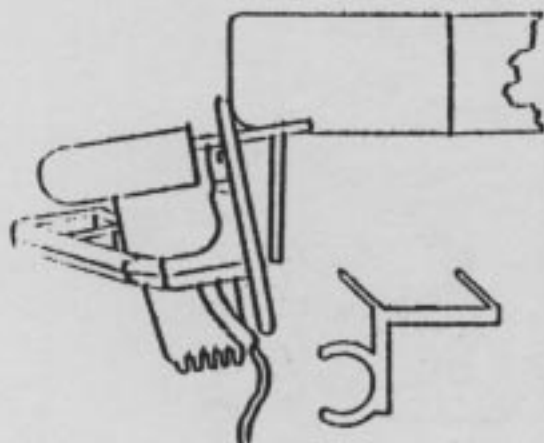

1. Using a skill saw, or the equivalent, machine a 1/8" slot 5/8" deep above the tile, as you see in drawing #1. The slot is machined at a 2 to 3 degree angle. It is recommended to cut this slot with an 8" dry-cut diamond blade. Carbide blades can be used but it takes several blades to groove the entire pool and much more time to do it.

2. Using the R.T.V. silicon adhesive, furnished in the side kit, place a 1/8" bead of R.T.V. in between the two flexible lips on top of the angle.

3. Now, with a 3/4" block of wood, drive the top of the angle into the machined slot. The R.T.V. will bond the new tile strip to the decking above only, so that the tile strip becomes a crack hider with deck movements, just like the original.

4. The upper lip that enters the slot first will not allow the tile strip to withdraw and the outer lip retains the R.T.V. The 2 to 3 degree angle causes the exposed face of the tile strip to lie firmly against the tile.

5. This dry-cut 8" diamond blade can be purchased at Stegmeier Corporation. SuperVision part no. SV-LS21, SV-LS42.

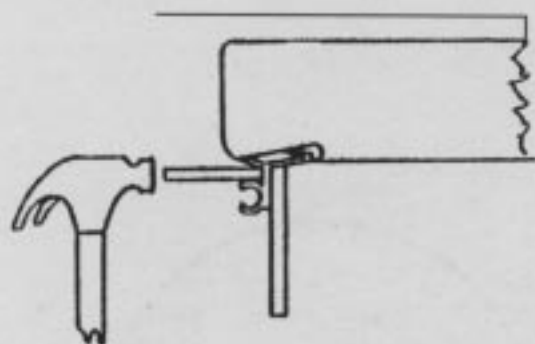

## LENS INSTALLATION - CONCRETE

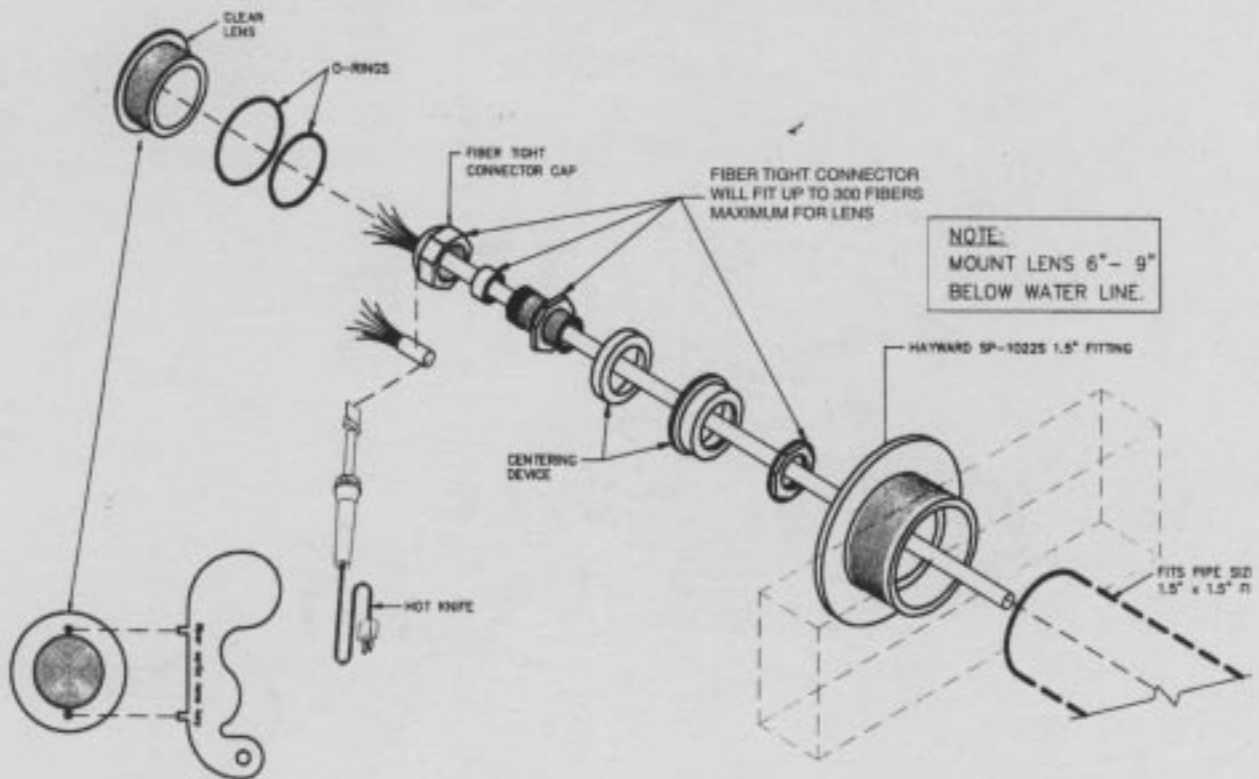

### CONCRETE/GUNITE

Install lens assembly after gunite is set.

1. Run the fibers through the conduits from the lens location towards the light source, using a fish tape. Leave approximately 16' of extra fibers above the ground for the fiber head to be installed.
2. At the lens location: run fiber through the wall fitting, leaving 4-6" of fiber from the wall fitting. Cut back the black jacket (CAUTION: DO NOT CUT OR SCRATCH THE EXPOSED FIBERS). Feed fiber through the Centering Device and through the fiber tight connector until approximately 1/2" - 1" of raw fibers will come through the fiber tight connector. Tighten the cap with a wrench or pliers, this operation is to prevent the fibers from slipping out. Using a Hot Knife, cut the exposed fibers as flush as possible to the tightening cap. Apply even pressure on the fibers, do not saw back and forth. (CAUTION: SAWING BACK AND FORTH WILL DAMAGE THE FIBERS). While cutting the fibers, be careful not to melt the tightening cap with the hot knife.
3. Slide the fibers with the Centering Device back into the wall fitting until Centering Device sits tight in the wall fitting.
4. Take the clear threaded lens with the two O-rings and thread the lens into the housing until snug. (Lubricating the O-rings before threading the lens will insure a watertight seal). Use the lens key to hand tighten the lens. Do not overtighten the lens, this may cause damage to the lens.

## LENS INSTALLATION - VINYL

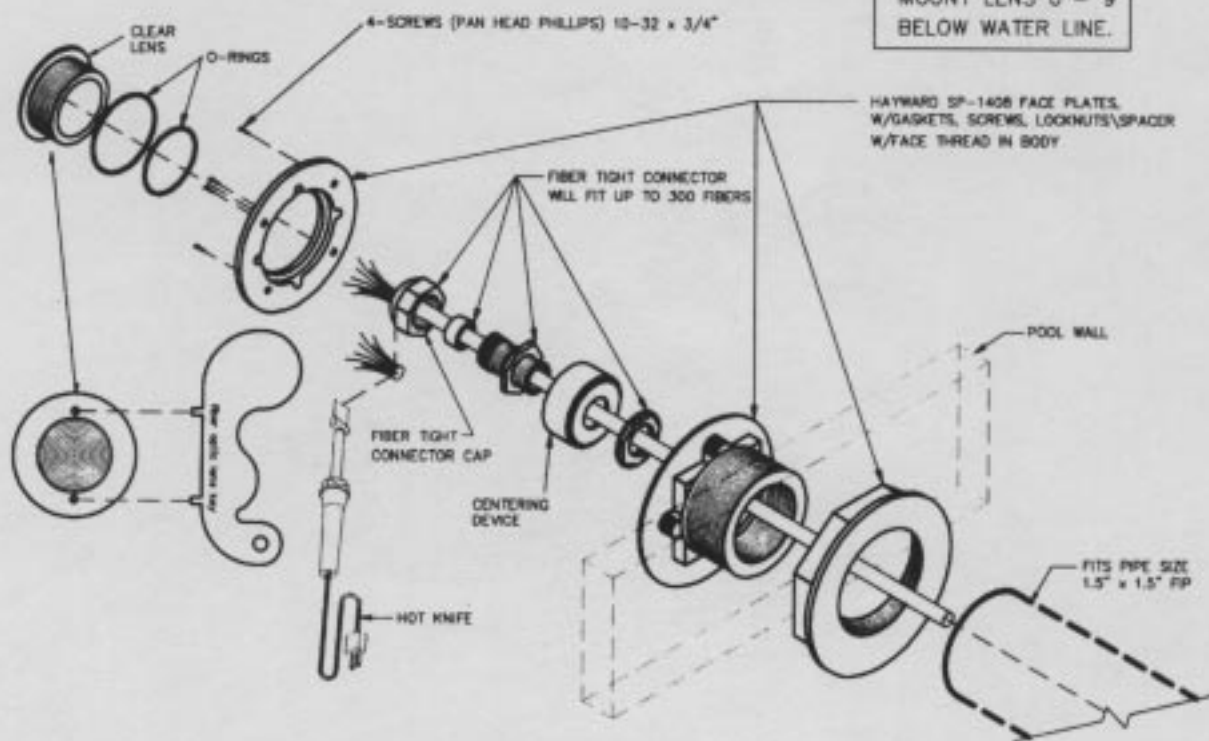

### VINYL:

1. Fill the pool with water to below the lens. Attach the face plate with the screws provided. Cut the liner in the center of the housing and remove excess pieces.
2. Run the fibers through the conduits from the lens location towards the light source, using a fish tape. Leave approximately 16" of extra fibers above the ground for the fiber head to be installed.
3. At the lens location: run fiber through the wall fitting, leaving 4-6" of fiber from the wall fitting. Cut back the black jacket (CAUTION: DO NOT CUT OR SCRATCH THE EXPOSED FIBERS). Feed fiber through the Centering Device and through the fiber tight connector until approximately 1/2" - 1" of raw fibers will come through the fiber tight connector. Tighten the cap with a wrench or pliers, this operation is to prevent the fibers from slipping out. Using a Hot Knife, cut the exposed fibers as flush as possible to the tightening cap. Apply even pressure on the fibers, do not saw back and forth. (CAUTION: SAWING BACK AND FORTH WILL DAMAGE THE FIBERS). While cutting the fibers, be careful not to melt the tightening cap with the hot knife.
4. Slide the fibers with the Centering Device back into the wall fitting until Centering Device sits tight in the wall fitting.
5. Take the clear threaded lens with the two O-rings and thread the lens into the housing until snug. (Lubricating the O-rings before threading the lens will insure a watertight seal). Use the lens key to hand tighten the lens. Do not overtighten the lens, this may cause damage to the lens.

## LENS INSTALLATION - FIBERGLASS

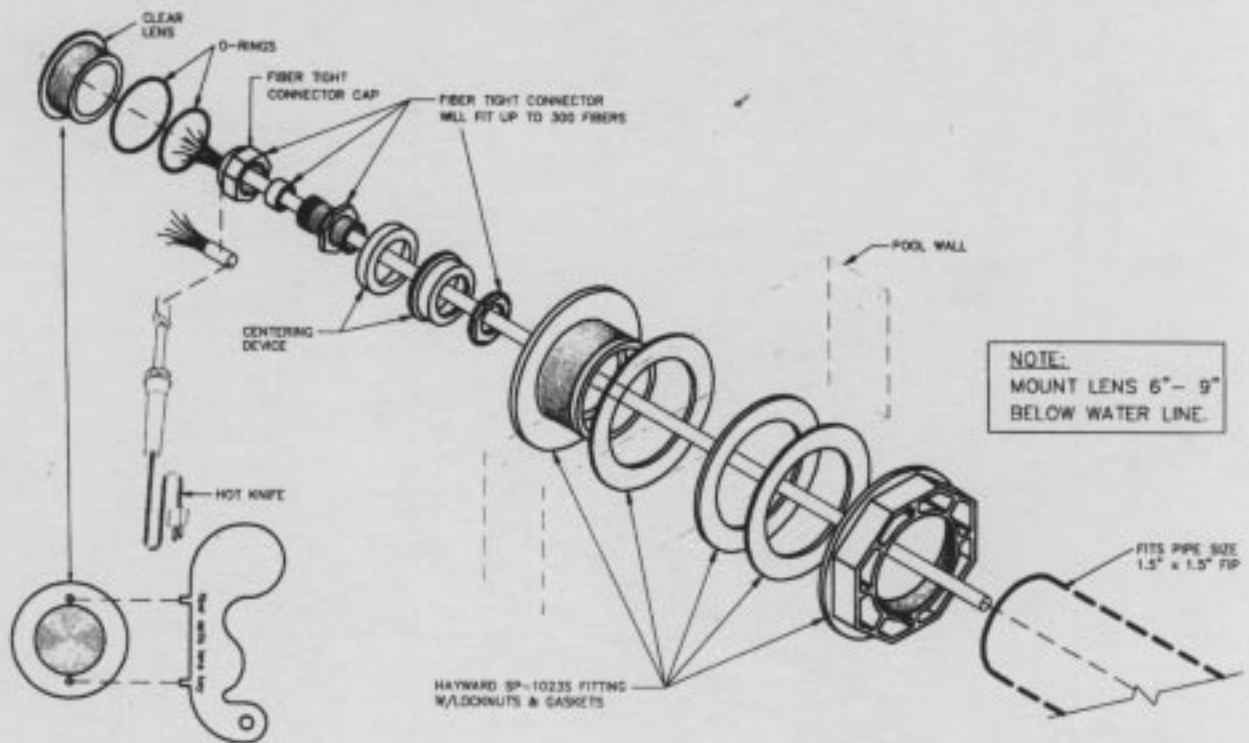

**NOTE:**  
MOUNT LENS 6" - 9"  
BELOW WATER LINE.

### FIBERGLASS

1. Run the fibers through the conduits from the lens location towards the light source, using a fish tape. Leave approximately 16' of extra fibers above the ground for the fiber head to be installed.
2. At the lens location: run fiber through the wall fitting, leaving 4-6" of fiber from the wall fitting. Cut back the black jacket (CAUTION: DO NOT CUT OR SCRATCH THE EXPOSED FIBERS). Feed fiber through the Centering Device and through the fiber tight connector until approximately 1/2" - 1" of raw fibers will come through the fiber tight connector. Tighten the cap with a wrench or pliers, this operation is to prevent the fibers from slipping out. Using a Hot Knife, cut the exposed fibers as flush as possible to the tightening cap. Apply even pressure on the fibers, do not saw back and forth. (CAUTION: SAWING BACK AND FORTH WILL DAMAGE THE FIBERS). While cutting the fibers, be careful not to melt the tightening cap with the hot knife.
3. Slide the fibers with the Centering Device back into the wall fitting until Centering Device sites tight in the wall fitting.
4. Take the clear threaded lens with the two O-rings and thread the lens into the housing until snug. (Lubricating the O-rings before threading the lens will insure a watertight seal). Use the lens key to hand tighten the lens. Do not overtighten the lens, this may cause damage to the lens.

**NOTE:** If the PVC pipe is on the way of the centering devices, a fiber tight connector can be used by itself.

## LENS INSTALLATION - WATERFALL

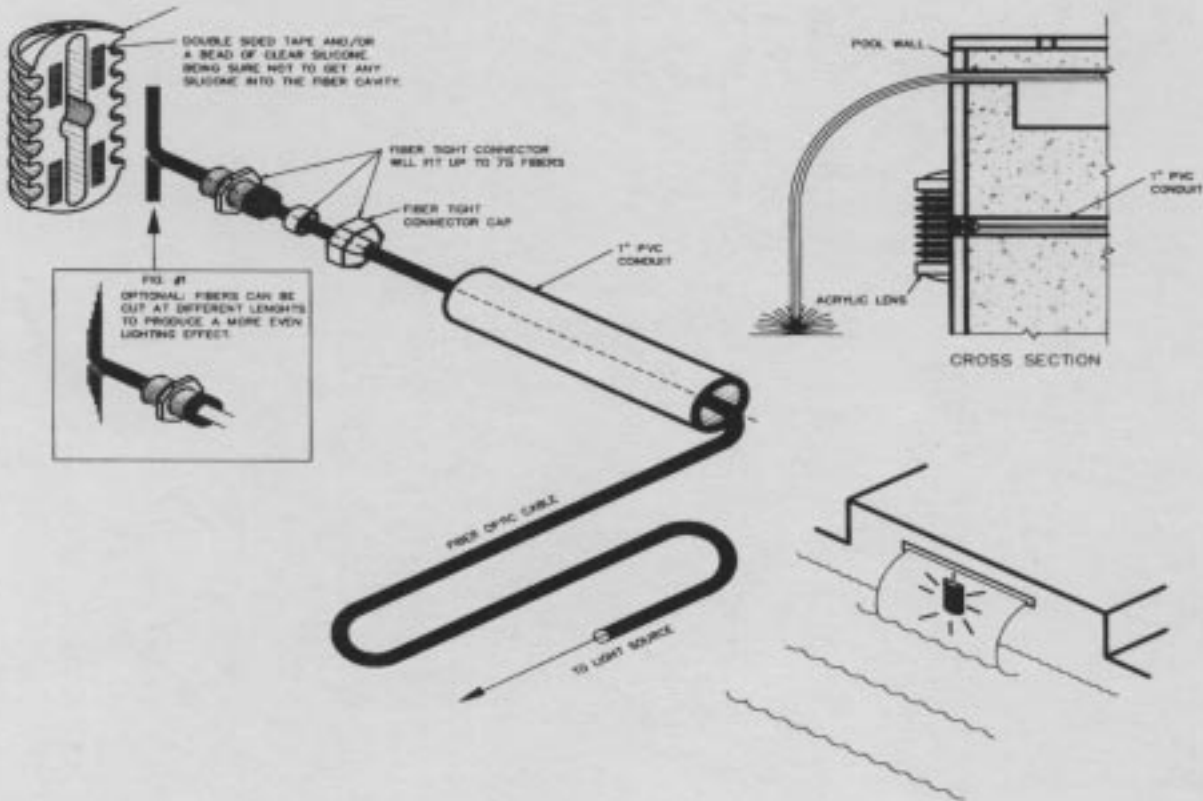

### FEATURE FIXTURE:

1. Run the fibers from light source location through the 1" conduit towards the lens location leaving 8" of cable sticking out of the pool wall.
2. Run fiber through the fiber tight connector leaving approximately 1" - 1-1/2" of cable. Remove the 1" - 1-1/4" of the fiber cable outer jacket exposing the raw fibers.
3. Point half of the fibers in each direction. Place fibers into the lens groove. Tighten the fiber connector by twisting the fiber tight connector so the fibers are secure in the lens. Tighten the fiber connector cap. (Optional: See fig. #1). NOTE: Make sure you first twist the connector into the lens, then you can tighten the connector cap.
4. Push the lens back into the 1" PVC conduit. Fasten lens to pool by using double-sided tape and/or clear silicone.

## LANDSCAPE FIXTURES

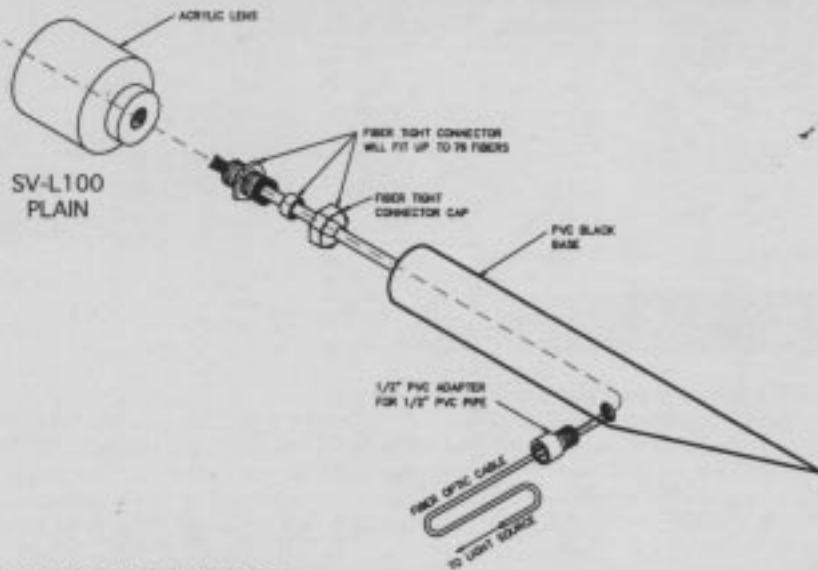

## OPTIONAL LENS

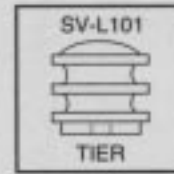

### LANDSCAPE FIXTURE:

1. Run the fibers from light source location through the conduit towards the landscape light location.
2. Run fiber through the 1/2" PVC adapter and through the fiber tight connector. Remove approximately 3/4" of the outer jacket of the cable, exposing the raw fibers.
3. Insert the fiber into the fiber tight connector and twist the connector cap. Tighten the connector by twisting the connector cap so the fibers are secure in the lens.
4. Snap the lens back into the PVC black base.

## ACCENT FIXTURES

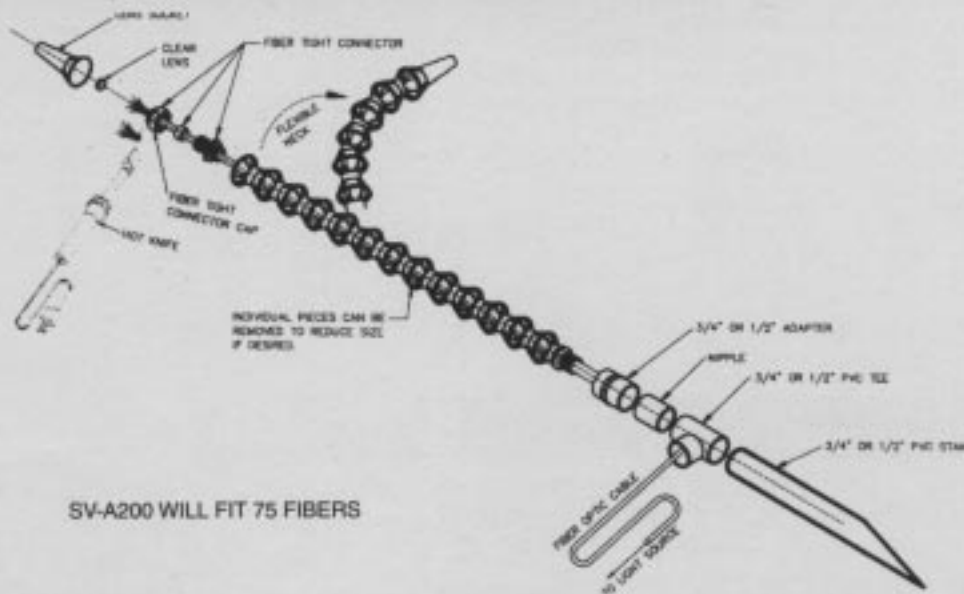

SV-A200 WILL FIT 75 FIBERS

### ACCENT FIXTURE.

1. Run the fibers from light source location through the conduit towards the landscape light location.
2. Run fiber through the PVC TEE adapter and through the fiber tight connector. Remove approximately 3/4" of the black outer jacket exposing the raw fibers.
3. Tighten the fiber by twisting the connector cap. (Make sure the fiber tight connector cap faces towards the lens as in the illustration).
4. Cut the exposed fiber flush with a hot knife, being careful not to touch the fiber tightening cap. Apply even pressure on the fibers, do not saw back and forth.
5. Pull back the fiber cable so the connector is well seated in the socket.
6. Snap the lens socket back onto the flexible neck.

## ELECTRIC HOT KNIFE

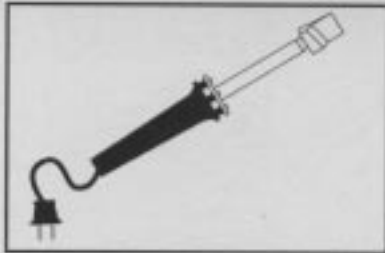

### SV-E30 - Electric hot knife

This special electric hot knife is designed to cut the fibers while polishing the ends of the fibers for superb light transmission.

Refer to page 11 for  
fiberhead installation

## CORDLESS HOT KNIFE

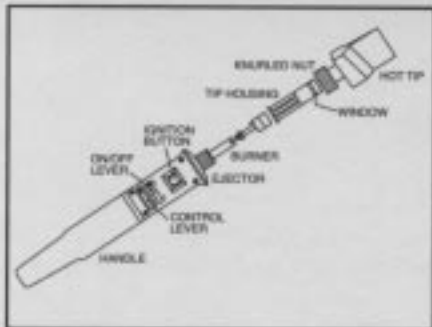

### SV-C30 - Cordless Hot Knife

This is the leading edge hot knife currently offered to the fiber optic market. This revolutionary hot knife is developed specifically for the fiber optic installer out in the field. The SV-CL30 is self-igniting and butane powered. It is a non-electrical heat tool with a variable temperature control. While cutting the ends of the fibers, the specially designed tip actually polished the fiber ends with heat to maximize light transmission to the fibers.

#### Cordless Hot Knife Features:

- No extension cords
- Eliminates the use of electricity
- Eliminates the "sawing" motion that damages fibers
- Simple and safe to operate under any condition
- Minimal waiting for the knife to heat up
- Refillable butane tank
- No matches or lighters necessary

#### MAINTENANCE INSTRUCTIONS:

To reduce the risk of personal injury, property damage, or damage to your self-igniting Ultratorch, do not attempt to repair handle. Please return the unit to the manufacturer for repair or replacement.

#### Problem:

1. Does not ignite

#### Probable Cause

- a. Empty tank
- b. Clogged ejector
- c. Too high or low fuel pressure
- d. Released ignition button too fast
- e. Spark igniter failed in burner

#### How to Correct

- a. Refill with butane fuel
- b. Replace with new ejector
- c. Slide control level to a higher or lower position
- d. Re-read "How to Use as a Soldering Iron"
- e. Replace with new burner

2. Spark does not ignite fuel

- a. Backfire after ignition

- a. Repeat ignition, pushing and releasing button SLOWLY

3. Knife tip does not heat up

- a. Used-up catalyst
- b. Insufficient fuel pressure
- c. Ejector is clogged

- a. Replace with new soldering/heat tip
- b. Refill with butane fuel
- c. Replace with new ejector

## LENS KEY

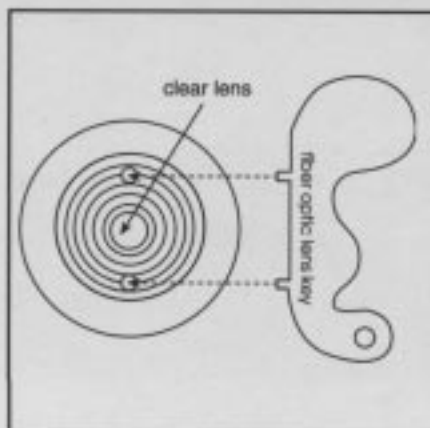

### SV-LKEY-Lens Key

Reusable metal key for locking/unlocking the clear lens on the SV-G, F and V series lenses.

## ADHESIVES



### **Novagard Tile Adhesive SV-NGC**

A one part clear RTV silicone adhesive, sealant specially formulated for the adhesion to ceramic tile. This low odor, neutral cure silicone provides excellent adhesion to ceramic, masonry, wood, metal, fiberglass, acrylic, ravel, green or wonder board and most plastic. Ideal for all mounting and securing Super Vision plastic fiber optic tracks.

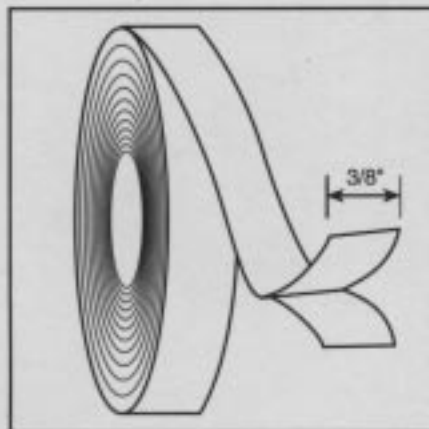

### **Double-Sided Tape SV-X2 TAPE (1/2") SV-X4 TAPE (1/4")**

The SV-X2 tape is a firm acrylic pressure-sensitive adhesive system. It features very high adhesion to a variety of surfaces. Excellent shear holding power and UV resistance. Ideal for mounting and securing Super Vision fiber optic tracks.

#### **Application Technique:**

1. Bond strength is very dependent upon the amount of adhesive-to-surface contact developed. Firm application pressure develops better adhesive contact and thus improves bond strength.
2. To obtain optimum adhesion, the bonding surfaces must be clean, dry and well unified. Some typical surface cleaning solvents are isopropyl alcohol or heptane. Follow manufacturers precautionary warnings and suggested handling procedures while using solvents.
3. Ideal tape application temperature range is 70°F to 100°F (21°C-38°C). Initial tape application to surfaces at temperatures below 50°F (10°C) is not recommended because the adhesive becomes too firm to adhere readily. However, once properly applied, low-temperature holding is satisfactory.
4. Ultimate bond strength can be accelerated and increased by exposure of the bond to temperature such as 150°F (66°C) for about one hour. Other heat range and time cycles may also be used to soften the adhesive. This provides better adhesive wetout onto substrates.

**Note:** To be used in conjunction with Novagard adhesive.

## TROUBLESHOOTING

	SV-2000	SV-250H	SV-25T
<b><u>Illuminator will not operate:</u></b>			
Make sure unit is wired properly.	X	X	X
Check and see if the fuse is blown. Extra fuse is provided in the fuse holder.	N/A	X	N/A
Make sure the key switch is turned all the way clockwise.	X	N/A	N/A
If restart, let cool down for about 3 minutes.	X	N/A	N/A
Contact your Hayward service representative if above steps fail.	X	X	X
<b><u>Illuminator lamp will not light, but the fan is on:</u></b>			
Shut off illuminator immediately.	X	X	X
Check bulb connections.	X	X	X
If restart, let lamp cool down for about 3 minutes	X	N/A	N/A
If lamp still doesn't operate, replace lamp. "See Maintenance Section".	X	X	X
Contact your Hayward service representative if above steps fail.	X	X	X
<b><u>Illuminator lamp works, but fan is not on:</u></b>			
Shut off illuminator immediately.	X	X	X
Check fan connection.	X	X	X
Contact your Hayward service representative if above steps fail.	X	X	X
<b><u>Illuminator works but does not change color:</u></b>			
Make sure the color wheel switch on the back of the light source is on the "on" position.	N/A	X	X
Be sure there are no obstructions in the way of the color wheel.	X	X	X
Check and see if the color wheel nut is on tight	X	X	X
Check to see if fiber head fibers are touching color wheel.	X	X	X
<b><u>Illuminator intensity dims over a period of time:</u></b>			
Remove fiber head and inspect fibers for a flush cut at the end of the fiber head	X	X	X
Make sure glass filter and color wheel are clean. (Clean with lens paper and any glass cleaner product)	X	X	X
Check to see if fiberhead is inserted all the way into the motor plate.	X	X	X
Check to see if fan is working properly	X	X	X
Make sure fiber cable exits straight out the light source without excess bending.	X	X	X
Check to see if fibers are melting or discoloring in the end of fiber head. (Typical cause: improper ventilation)	X	X	X
<b><u>Illuminator shuts down after a period of time:</u></b>			
Check if fan is working properly.	X	X	X
Check location of light source for proper ventilation requirements.	X	X	X
Check for obstruction of air vents.	X	X	X
<b><u>Illuminator melts fiber at the fiber head:</u></b>			
Check location of light source for proper ventilation requirements.	X	X	X
Check if fan is working properly.	X	X	X
Check for obstructions at air vents.	X	X	X
<b><u>Water is entering into the light source:</u></b>			
Check to see if louvres are facing in the-down position.	X	N/A	N/A
Make sure if wall mounted that fiber head is facing down.	X	N/A	N/A
Check all gaskets for defects.	X	N/A	N/A

**Note:** Before servicing, shut off power to illuminator. Any troubleshooting not listed above should be done by a trained Hayward representative or warranty could be voided.

Any questions, call your local Hayward service representative.

## LIMITED WARRANTY

Hayward warrants its products, **excluding lamps**, to be free from defects in material and/or workmanship, under normal use, conditions and service, for a period of **ONE YEAR** from the date of original purchase.

In the event of a defect in material or workmanship during the warranty period, Hayward will repair or replace (at its discretion) its products under the conditions of the Warranty. Hayward will do so at its expense for the materials but not for shipping. **THIS REMEDY IS THE SOLE AND EXCLUSIVE REMEDY FOR ANY AND ALL CLAIMS RELATING TO ANY BREACH OF WARRANTY BY HAYWARD.**

### LIMITATIONS, EXCLUSIONS AND OTHER RIGHTS:

1. Except as provided herein, Hayward makes no other warranties, express or implied, including but not limited to the implied warranties of merchantability or fitness for a particular purpose, at all such warranties are expressly disclaimed. Some states do not allow the exclusion of an implied warranty, so the above exclusion may not apply to you.
2. Hayward is not responsible for defects or malfunctions in and/or damage to Lighting Systems where a sale is specifically made without warranty. In such sales the disclaimers of warranty and liability; set forth above, shall continue to apply.
3. The Warranty covers normal consumer use and does not cover damage which occurs in shipment or damage or failure which results from alteration, accident, theft, misuse, abuse, abnormal use, negligent installation, improper maintenance or where adequate care has not been taken to prevent damage to the Lighting System.
4. **THIS WARRANTY GIVES YOU SPECIFIC LEGAL RIGHTS, AND YOU MAY ALSO HAVE OTHER RIGHTS WHICH VARY FROM STATE TO STATE.**

If you discover a defect or malfunction during the period to which this Warranty applies, write or phone Hayward for information on receiving warranty service.



## **HAYWARD POOL PRODUCTS, INC.**

Hayward Pool Products, Inc.  
900 Fairmount Avenue  
Elizabeth, NJ 07207  
(908) 351-5400

Hayward Pool Products, Inc.  
2875 Pomona Boulevard  
Pomona, CA 91768  
(909) 594-1600

Hayward Pool Products Canada  
2680 Plymouth Drive  
Oakville, Ontario L6H 5R4  
(905) 829-2880

Hayward S.A.  
Zone Industrielle de Jumet  
B - 6040 Charleroi (Belgium)  
011-32-71-412-030